

EN 81-20 EN 81-50

SPECIALISTS IN
SAFETY COMPONENTS
FOR LIFTS

ON-BOARD GOVERNORS

QUASAR T-25 BIDIRECTIONAL OVERSPEED GOVERNOR INTEGRATED WITH THE SAFETY GEAR

CE 1027

It is assembled
onto the T25
linkage where, in
turn, ASG
progressive safety
gear is installed

Tripping speed = $0,3 \div 2,33$ m/s
Rated speed ≤ 2 m/s
 \emptyset pulley = 120 mm; \emptyset rope = 4 mm
Hardened groove
Overspeed switch
Remote tripping
UCM available
Fulfills EN 81-20/50



QUASAR SV BIDIRECTIONAL OVERSPEED GOVERNOR FIXED TO THE CAR

CE 1027

Tripping speed = $0,3 \div 2,63$ m/s
Rated speed $\leq 2,18$ m/s
 \emptyset pulley = 120 mm; \emptyset rope = 4 mm
Hardened groove
Overspeed switch
Remote tripping
UCM available. Fulfills EN 81-20/50

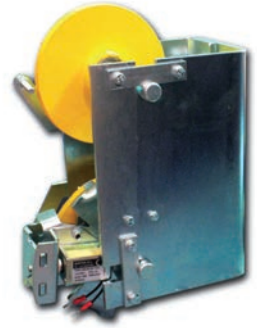

STAR BIDIRECTIONAL OVERSPEED GOVERNOR FIXED ON/UNDER CAR

CE 1027

Tripping speed = $0,35 \div 2,72$ m/s
Rated speed $\leq 2,3$ m/s
 \emptyset pulley = 200 mm; \emptyset rope = 6 mm
Overspeed switch. Remote tripping.
UCM available. Fulfills EN 81-20/50



STAR PLUS BIDIRECTIONAL OVERSPEED GOVERNOR FIXED ON/UNDER THE CAR

CE 1027

Tripping speed = $0,35 \div 2,72$ m/s
Rated speed $\leq 2,3$ m/s
 \emptyset pulley = 200 mm; \emptyset rope = 6 mm
Overspeed switch. Remote tripping. Encoder (optional).
UCM available. Fulfills EN 81-20/50

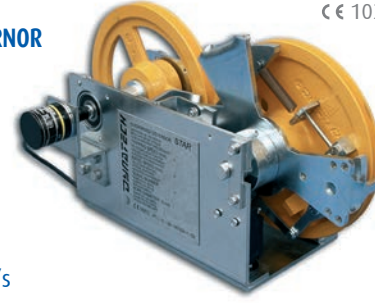

TENSING SYSTEMS FOR ON-BOARD GOVERNORS

STANDARD TENSING SYSTEM

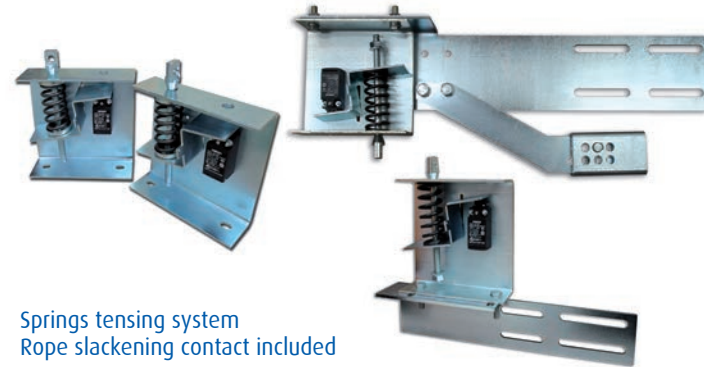

Springs tensing system
Rope slackening contact included

ROLLER TENSING SYSTEM

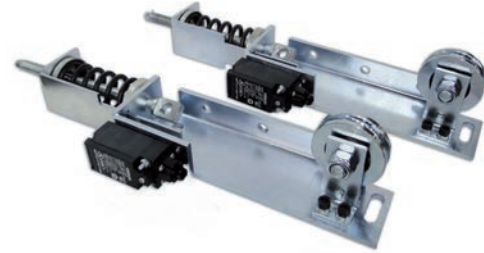

Springs tensing system
Rope slackening contact included
Ideal for installations with a reduced headroom and pit

WEIGHING DEVICES

ECO ELECTROMECHANICAL WEIGHING DEVICE



Silentblocks deformation measurement device
Feeding: 12 - 32 V DC
Overload relay: (NC or NO)
Overload sound signal



DYNATECH® 2019/09



Leading innovation



Dynatech, Dynamics & Technology, S.L.

Polígono Ind. de Pina de Ebro
Sector C, p-9
50750 Pina de Ebro
España (Spain)

info@dynatech-elevation.com
www.dynatech-elevation.com

(T) +34 976 165 860

(F) +34 976 165 964

Products Range



DYNATECH



INSTANTANEOUS SAFETY GEARS

IN-3000 / IN-3000 G10
INSTANTANEOUS SAFETY GEAR

€ € 1027



For tripping speed 1 m/s:
P+Q max. 8 mm Cold drawn guide rail = 2480 kg
P+Q max. 9 mm Cold drawn guide rail = 2837 kg
P+Q max. 9 mm Machined guide rail = 1855 kg
P+Q max. 10 mm Cold drawn guide rail = 3364 kg
Guide rail type: Cold drawn or machined and oiled or dry.
FULFILLS EN 81-20/50

IN-6000
INSTANTANEOUS SAFETY GEAR

€ € 1027

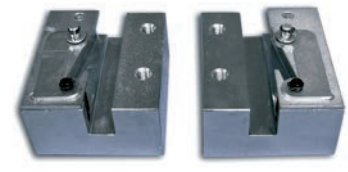

For tripping speed 1 m/s:
P+Q max. Cold-drawn guide rail= 6601 kg
P+Q max. Machined guide rail= 5295 kg
Guide rail type: Cold drawn or machined and oiled or dry.
Admissible guide rail thickness: 16 mm
FULFILLS EN 81-20/50

ASG ACTIVATIONS

T-25 / T-25 UD
EXTENSIBLE DRIVING BARS



Distance between guides: from 600 to 4000 mm
Safety switch (optional).

T-25 XL / T-25 UD XL



Distance between guides: from 600 to 2600 mm
Safety switch (optional).

PROGRESSIVE SAFETY GEARS WITH LATERAL DISPLACEMENT

ASG-100
ASG-120
ASG-121
ASG-221
ASG-65
UNIDIRECTIONAL

€ € 1027

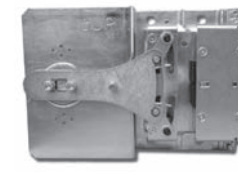

ASG-100 UD
ASG-120 UD
ASG-121 UD
ASG-221 UD
ASG-65 UD
BIDIRECTIONAL



	ASG-100 ASG-100 UD	ASG-120 ASG-120 UD	ASG-121 ASG-121 UD	ASG-221 ASG-221 UD	ASG-65 ASG-65 UD
	Cold-drawn Oiled	Machined Oiled	Machined Dry	Machined Dry	Cold-drawn Oiled
Permissible mass					
Min	515 kg	693 kg	598 kg	754 kg	790 kg
Max	2139 kg	4233 kg	4019 kg	3284 kg	2214 kg
Max Tandem config.	4278 kg	8466 kg	8038 kg	6568 kg	4428 kg
Admissible guide rail thickness					7 to 16 mm
Minimum gripping width					≥ 25 mm = 20 mm
Maximum tripping speed	2,33 m/s			3,9 m/s	2,33 m/s
FULFILLS EN 81-20/50					HIGH SPEED

TANDEM CONFIG.



Used with: T-25 /T-25 UD
T-2 & T-3
Safety switch (optional).

PROGRESSIVE SAFETY GEARS

PQ-4000-UD
BIDIRECTIONAL

€ € 1027



Minimum P+Q = 2173 kg
Maximum P+Q = 4023 kg
Max. Trip. Speed = 2,5 m/s
Guide rail type: Machined and oiled.
Admissible guide rail thickness: 7 to 16 mm
Minimum gripping width =25 mm
FULFILLS EN 81-20/50

PR-2000-UD
BIDIRECTIONAL

€ € 1027

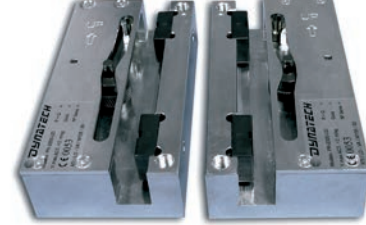

Minimum P+Q = 537 kg
Maximum P+Q = 1222 kg
Max. Trip. Speed = 2,0 m/s
Guide rail type: Cold drawn and oiled.
Admissible guide rail thickness: 5 to 16 mm
Minimum gripping width =25 mm
FULFILLS EN 81-20/50

ELECTROMECHANICAL SAFETY GEARS

UNIDIRECTIONAL eASG
ELECTROMECHANICAL ACTIVATION



Component designed to work with
SIL 3 electronic devices certified
according to standard

Safety Gears: The entire range of
ASG progressive safety gears.
Power supply:
• 24 VDC

OVERSPEED GOVERNORS

QUASAR
BIDIRECTIONAL OVERSPEED GOVERNOR

€ € 1027



Tripping speed = 0,3 ÷ 2,63 m/s
Rated speed=< 2,18 m/s
Ø pulley = 120 mm
Ø rope = 6 mm/6,5 mm
Hardened groove
Overspeed switch
Remote tripping
UCM available. Fulfills EN 81-20/50

VEGA
BIDIRECTIONAL OVERSPEED GOVERNOR

€ € 1027

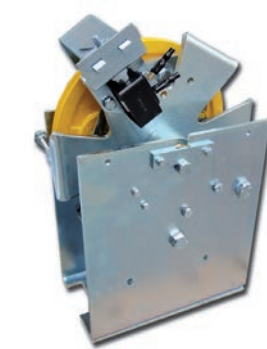

Tripping speed = 0,4 ÷ 2,87 m/s
Rated speed=< 2,4 m/s
Ø pulley = 200 mm
Ø rope = 6mm/6,3mm/6,5mm
Hardened groove (optional).
Remote reset and remote tripping mechanism by
electrical acting (both optional).
UCM available. Fulfills EN 81-20/50

VEGA PLUS
BIDIRECTIONAL OVERSPEED GOVERNOR
WITH ENCODER

€ € 1027

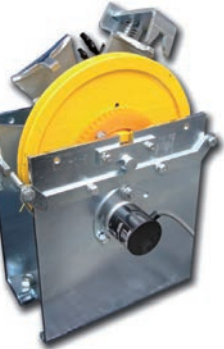

Encoder (optional)
Same features as
VEGA

PR-2500-UD V.35
BIDIRECTIONAL

€ € 1027

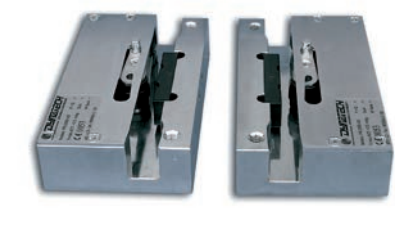

Minimum P+Q = 613 kg
Maximum P+Q = 1955 kg
Max. Trip. Speed = 2,5 m/s
Guide rail type: Cold drawn or machined and oiled.
Admissible guide rail thickness: 7 to 16 mm
Minimum gripping width =25 mm
FULFILLS EN 81-20/50

PR-2500-UD V.50
BIDIRECTIONAL

€ € 1027

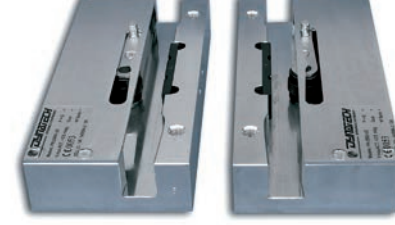

Minimum P+Q = 613 kg
Maximum P+Q = 1955 kg
Max. Trip. Speed = 2,5 m/s
Guide rail type: Cold drawn or machined and oiled.
Admissible guide rail thickness: 7 to 16 mm
Minimum gripping width =25 mm
FULFILLS EN 81-20/50

BIDIRECTIONAL eASG
ELECTROMECHANICAL ACTIVATION

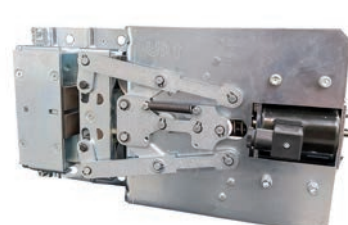

Component designed to work with
SIL 3 electronic devices certified
according to standard

Paracaídas: Toda la gama de paracaídas
progresivos ASG.
Power supply:
• 24 VDC

VEGA HS
BIDIRECTIONAL OVERSPEED GOVERNOR

€ € 1027

HIGH SPEED

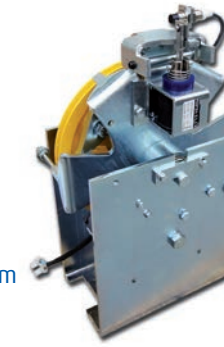

Tripping speed = 2,87 ÷ 4,2 m/s
Rated speed =< 3,4 m/s
Ø pulley = 200mm
Ø rope = 6mm/6,3mm/6,5mm
Hardened groove (optional).
Remote reset and remote tripping mechanism by
electrical acting (both optional).
UCM available. Fulfills EN 81-20/50

VEGA 300
BIDIRECTIONAL OVERSPEED GOVERNOR

€ € 1027

HIGH SPEED

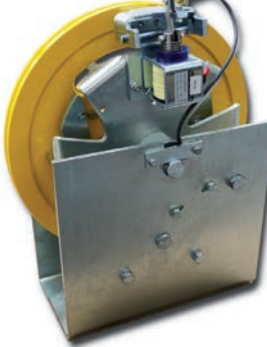

Tripping speed = 0,5 ÷ 4,2 m/s
Rated speed =< 3,4 m/s
Ø pulley = 300mm
Ø rope = 6mm / 6,5mm
Test groove (optional).
Hardened groove (optional).
Remote reset and remote tripping mechanism by
electrical acting (both optional).
UCM available. Fulfills EN 81-20/50

LBDs FAMILY
BIDIRECTIONAL OVERSPEED GOVERNORS

€ € 1027

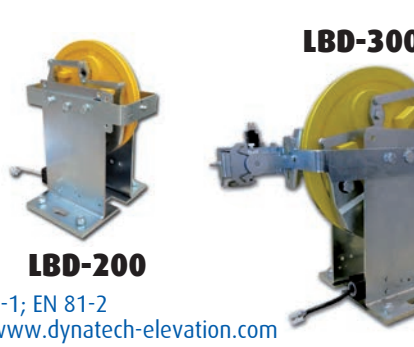

LBD-200
Fulfills EN 81-1; EN 81-2
More info: www.dynatech-elevation.com

LBD-300

LINKAGES

T-1
EXTENSIBLE
DRIVING BAR



Distance between guides: from 600 to 4000 mm

Safety switch (optional)
Used with: Instantaneous

T-3 / T-2
EXTENSIBLE
DRIVING BAR



Distance between guides: from 600 to 4000 mm

Safety switch (optional)
T-3 Used with: PR-2500-UD V.50 PR-2000-UD
PQ-4000-UD
T-2 Used with: PR-2500-UD V.35

FIXING KIT

RENO
RENO FIXING KIT FOR NEW OR EXISTING FRAMES

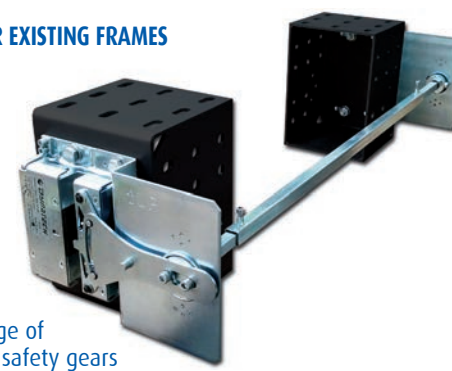

Safety Gears: The entire range of
PR, PQ and ASG progressive safety gears

Governors: Quasar T-25

TENSING PULLEYS

COMPACT TENSING PULLEY 126



Springs tensing pulley.
Steel pulley.
Rope tensioner: That will make rope
re-tensioning easier if required.
Rope slackening contact included.
Rope Out Protection included.

COMPACT TENSING PULLEY 200



Springs tensing pulley.
Casting pulley.
Rope tensioner: That will
make rope re-tensioning
easier if required.
Rope slackening contact
included.
Rope Out Protection included.

TENSION WEIGHT 200



Rope slackening contact included.
Rope Out Protection included.
Protection plate included.
M14 forged clips included.

TENSION WEIGHT 300

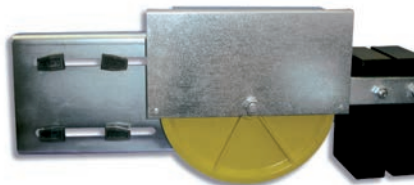

Rope slackening contact included.
Rope Out Protection included.
Protection plate included.
M14 forged clips included.

SPRINGS TENSING PULLEYS

TENSION WEIGHTS